

ASSEMBLY and INSTALLATION INSTRUCTIONS



Gas Conversion Kit Tube Heaters

View these instructions online at www.lbwhite.com

Kit Contents:

DESCRIPTION	QTY.
Instructions	1
Burner orifice	1
Manifold pipe	1
Burner inlet plate	1
Air inlet plate	1
Conversion documentation label	1
Honeywell conversion kit to Natural Gas	1
Pipe thread compound	1
Burner vane (Sentinel 125 & 150 ONLY)	1
Copper tube (Sentinel 125 & 150 ONLY)	1
¼" Clamp (Sentinel 125 & 150 ONLY)	1
Gasket (Sentinel 125 & 150 ONLY)	1
Pressure switch orifice	1

Tools required:

Pipe wrench
Ratchet
3/8 socket
9/16 socket
11/16 socket
3/16 Allen key
3/32 Allen key
9/64 Allen key

Materials required:

2- Gas pressure gauges capable of reading up to 35 in. W.C.
(may also be ordered from L.B. White, part number 00764)
2- 1/8 NPT hose barb fitting
General Purpose silicone sealant

Requirements:

- You must read and understand these instructions before beginning the conversion.
- You must be properly trained and have sufficient experience to install the gas conversion kit and test the heater for proper operation.
- Ensure the installation's gas type and pressure conform to the gas type and pressure requirements given on the conversion documentation label within the conversion kit.
- Ensure piping is of appropriate size for natural gas flow capacity.

Discussion:

The following instructions are common for use when converting fuel gas for single stage and two stage tube heaters. Where appropriate, specific instructions pertaining only to two stage heaters will be identified. These instructions pertain to only "B" design Oval 80 and "C" design Sentinel tube heaters. Refer to the dataplate on the burner box to determine design sequence (design sequence is the FIRST letter in the configuration number). If unsure, call L.B. White Company. Some components might not be used in conversion.

General Instructions:

- Close the main gas supply valve to the heater, and disconnect the heater's electrical supply.
- For reassembly, reverse the respective service procedure.
- Use pipe thread compound at all threaded connections.
- Ensure all threaded connections are tightened securely.

Section A: Changing Burner Inlet Plate / Orifice

1. Remove the ignitor mounting screws and igniter. See Fig. 1.

Do not force or bend ignitor during removal process.

FIG. 1

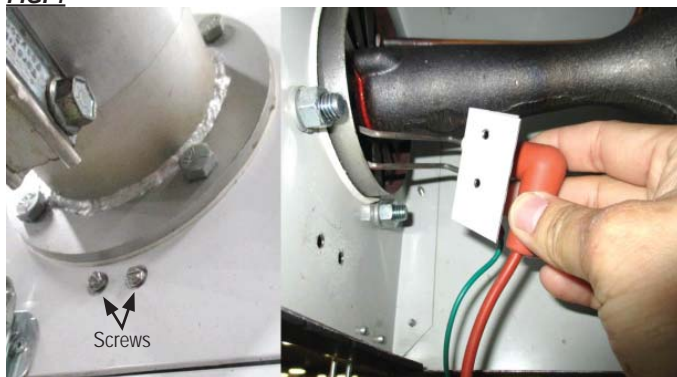

2. Remove the pressure switch tube from copper burner tube and remove burner mounting nuts. See Fig. 2.

FIG. 2

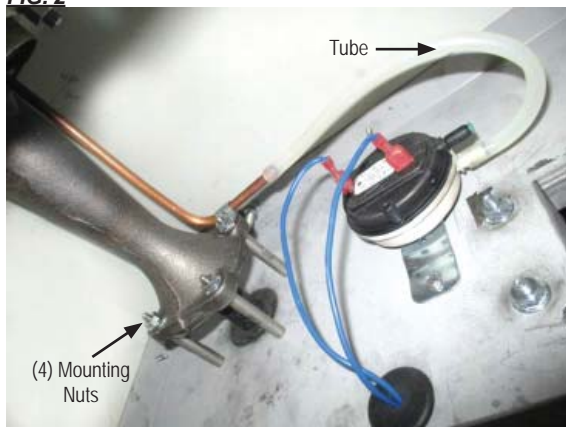

3. Slide the burner casting off its mounting studs and pull the burner casting from the burner tube, pivot burner casting as necessary. See Fig. 3.

Do not force or bend vanes on burner vane plate during removal process.

FIG. 3

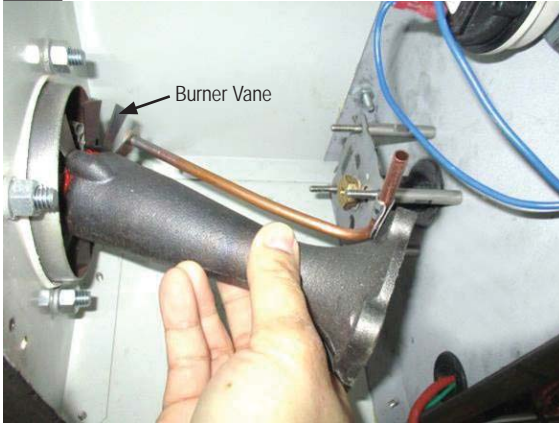

4. Remove orifice and burner inlet plate See Fig. 4.

FIG. 4

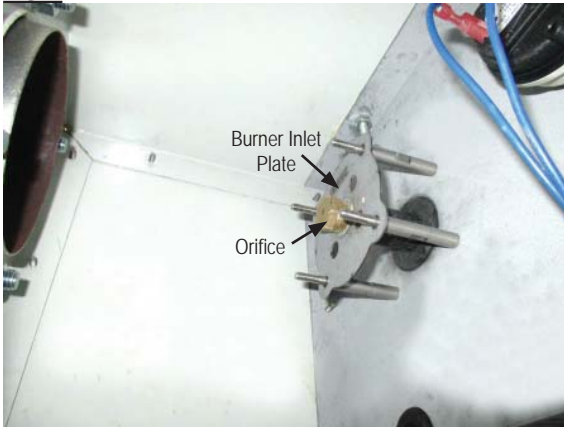

**If manifold pipe is of type 1, continue to step 5.
If manifold pipe is of type 2, skip to step 7.**

Manifold pipe type 1



Manifold pipe type 2



5. Remove manifold pipe.
6. Replace with manifold pipe from kit. Ensure rubber grommet in center partition panel does not fall out. See grommet location in picture of type 2 of manifold pipe.
7. Install orifice and burner inlet plate from conversion kit.

Sentinel 100 and Oval 80

- Reinstall original burner casting using mounting nuts removed earlier.
- Sentinel 100 skip to section B
- Oval 80 skip to section C

Sentinel 125 and Sentinel 150 ONLY

If burner assembly is of type A, continue to step 8.

If burner assembly is of type B, skip to step 9.

Burner assembly type A

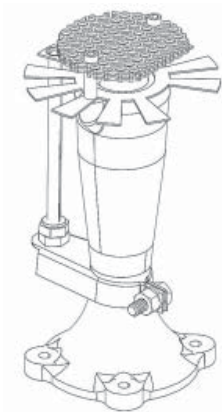

Burner assembly type B

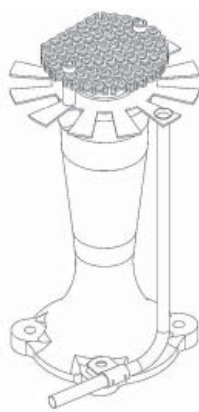

8. Remove bracket bolt. See Fig. 5.

FIG. 5

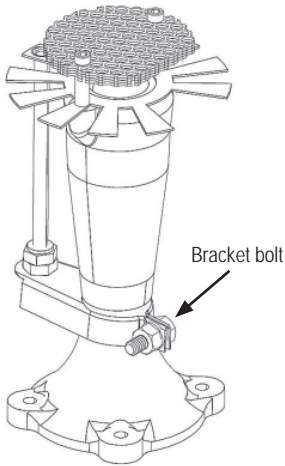

9. Remove 9/64 Allen head screws, burner screens, and spacers from burner casting. See Fig. 6.

FIG. 6

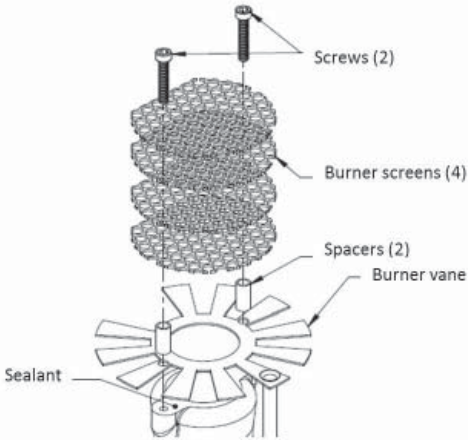

10. Remove burner vane from burner casting and discard it along with bracket and original copper tube.
11. Remove all sealant from burner head.
12. Place burner gasket from conversion kit onto burner casting head. See Fig. 7.

FIG. 7



13. Install burner vane from conversion kit along with spacer and burner screens, using screws removed earlier. Securely tighten screws. Ensure the straight edges of the burner screens and the burner vane ignitor opening align with each other. See Fig. 8.

FIG. 8

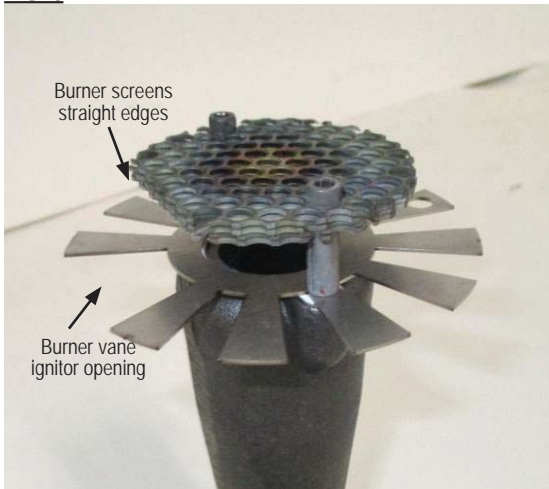

14. Insert copper tube from conversion kit through the burner vane. Install ¼" clamp from conversion kit onto copper tube. See Fig. 9.

FIG. 9

15. Remove clear tube from pressure switch and inspect pressure port for blue orifice. If the pressure switch **does not** have a blue orifice, fully insert the blue orifice from the conversion kit. See Fig. 10. If the pressure switch **does** have a blue orifice installed, leave as is.

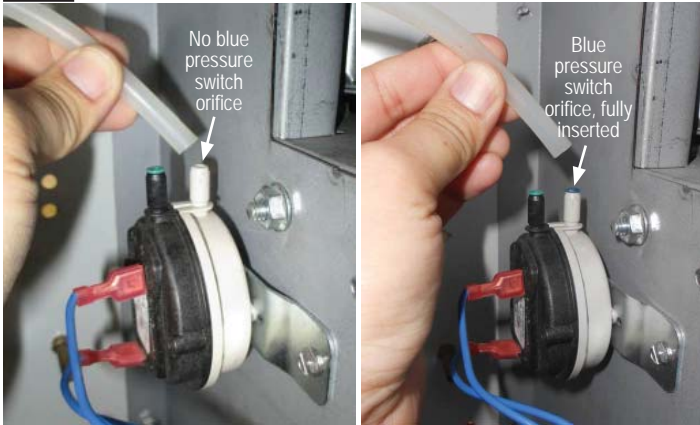
FIG. 10

16. Firmly push the clear tube onto the pressure switch port with the blue orifice.

17. Install burner casting assembly back onto mounting studs using mounting nuts removed earlier. Ensure ignitor opening of burner vane is directed down toward ignitor mounting screw holes. See Fig. 11.

Do not force or bend vanes on burner vane plate during installation.

FIG. 11

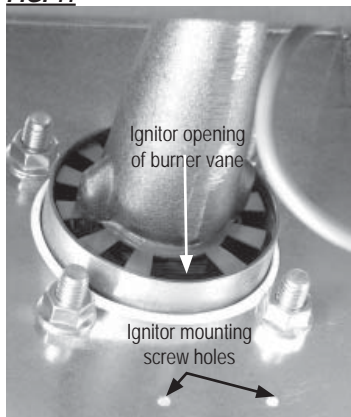

19. Firmly push the other end of the clear tube onto the copper tube.
20. Install the ignitor. Pivot ignitor as necessary to ensure ignitor is properly inserted into position. Secure with screws removed earlier.

Do not force or bend ignitor during installation process.

Section B: Changing Air Inlet Plate

1. Remove supply air flex tube from heater.
2. Remove the screws securing the air inlet plate. See Fig. 12.

FIG. 12



3. Remove the air inlet plate.

Plate is adhered with silicone to Burner Box.

4. Install new air inlet plate from the kit.
5. Reseal around outside of air inlet plate with silicone. (Not Supplied)

Section C: Converting the Gas Control Valve

1. Remove the screws securing the valve to the burner box. See Fig 13.

FIG. 13**Sentinel****Oval 80**

roughly dry.
 leg of the heater can cause severe or property damage due to water leakage.
 components, connections and wires that shock or component failure.
 of components causing corrosion lead to gas leaks and fire or in the leak.
 components of the heater with a or cloth, or compressed air.

WARNING

Land Explosion Hazard
 instructions a safe distance away of:
 articles include wood or paper fibers, straw, and dust.
 heater in spaces, which contain in solids or airborne combustibles.
 some combustibles include sawdust, paint thinner, dust particles or resin.
 Use these instructions may result in severe.

Screws (4)

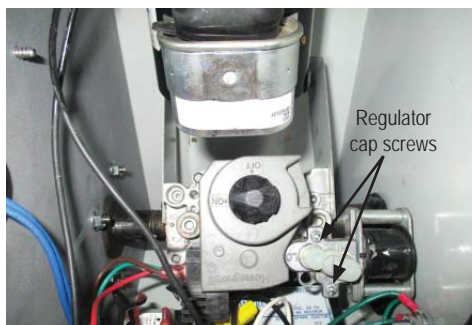

2. Rotate gas control valve for access to regulator cap screw(s). Fig. 14.

FIG. 14**Single Stage Valve****Two Stage Valve**

Single Stage Gas Valve Conversion (Fig. 15.)

1. Remove the regulator cap screw and pressure regulating adjusting screw.
2. Remove the existing spring (red) from the gas control valve.
3. Install the spring (silver) and pressure regulating adjusting screw from the Honeywell conversion kit.
4. Ensuring the pressure regulating adjusting screw is flush with the regulator top; turn the adjusting screw clockwise 10 complete turns.
5. Continue to Section D

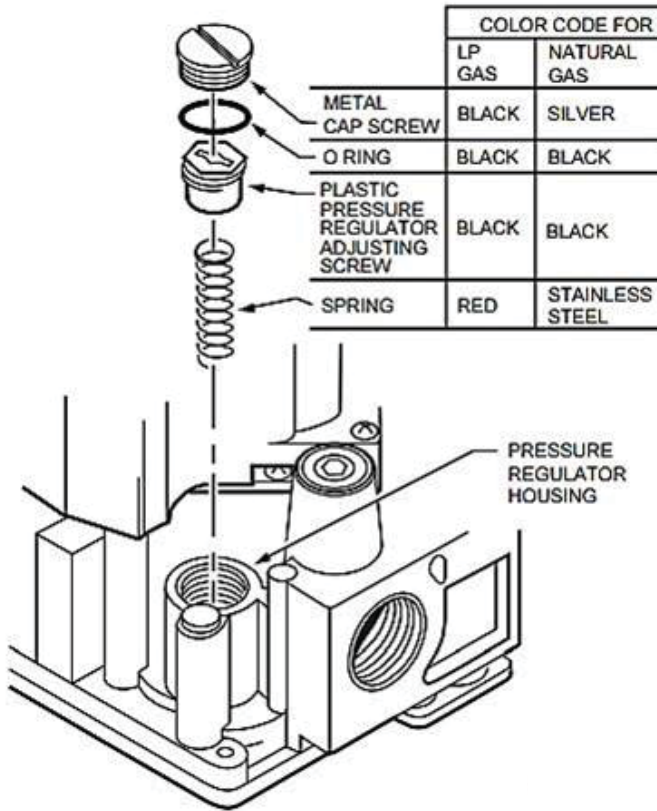
FIG. 15

Two Stage Gas Valve Conversion (Fig. 16.)

1. Remove pressure regulator cover screws.
2. Remove pressure regulator cover.
3. Removed the existing spring (black) from the gas control valve. Install the spring (white) from the Honeywell conversion kit.
4. Install pressure regulator cover onto valve. Tighten regulator cover screws securely.

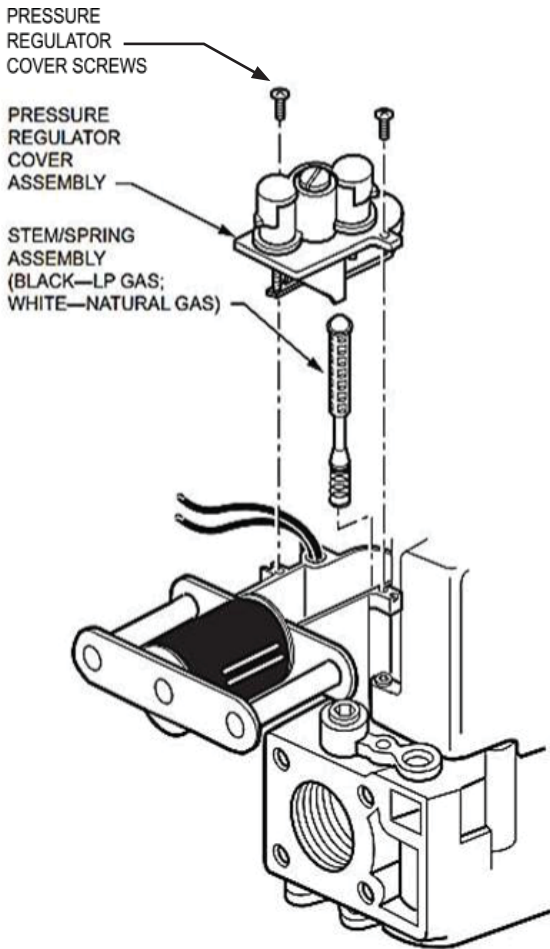
FIG. 16

Section D: Setting Gas Pressures

1. Using the 3/16 Allen key, remove the pressure tap plug from the outlet and inlet of the gas control valve.
2. Securely connect pressure barb fittings to the gas control valve. See Fig. 17.

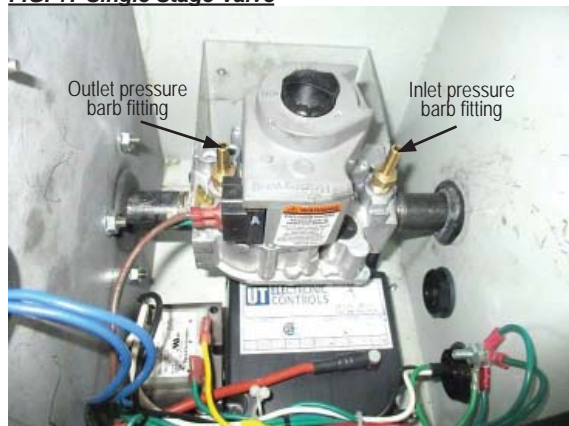
FIG. 17 Single Stage Valve***Two Stage Valve***

- Route gauge tubing through burner box air inlet to gas control valve. See Fig. 18.

FIG. 18



Single stage valve shown for representation of gauge tubing connection.

- Install gauge tubes onto pressure barb fittings.
- Trace the connected tubing back to the respective pressure gauge to determine which pressure gauge will measure inlet pressure or burner manifold pressure.
- Close and latch the burner box panel. Open the fuel supply valves to the heater.
- Reconnect the heater's electrical supply, and start the heater.

Section E: Setting Gas Pressures

General Instruction

- The pressure read at the inlet of the gas control is Inlet Pressure. The pressure read at the outlet of the gas control valve is burner manifold pressure.
- Refer to the Gas Conversion Documentation Label supplied with the conversion kit. Ensure pressures are set according to required specifications given on Gas Conversion Documentation Label.
- Verify proper inlet pressure. If the inlet pressure to the gas control does not agree with the Conversion Documentation Label, then the regulator controlling gas pressure to the heater requires adjustment. Proceed after proper inlet pressure has been established.
- Verify proper burner manifold pressure. If the pressure is less or greater than what is specified on the Conversion Documentation Label, adjustment of the burner manifold pressure is required.
- The burner box panel must be closed and latched for ignition to occur.
- The gas pressures setting process may require several adjustments of the burner manifold pressure. Therefore, several openings and closings of the burner box panel may be necessary.

Single Stage Gas Valve

1. Turn the regulator adjusting screw clockwise (CW) to increase or counterclockwise (CCW) to decrease the burner manifold pressure. Adjust pressure as needed. See Fig. 19 Single Stage.

With the heater operating, the pressure gauges must read the pressures specified on the natural gas conversion documentation label.

2. Once pressure has been set close the heater gas supply valve and disconnect from its electrical supply.
3. Proceed to Section F for completion.

FIG. 19



Two Stage Gas Valve

1. Start the heater to operate on high heat
2. Remove the pressure regulator adjustment cap.
3. Use the 3/32 Allen key to adjust the high pressure regulator to match the Conversion Documentation Label.
4. Turn the inner adjustment screw for HI pressure clockwise (CW) to increase or counterclockwise (CCW) to decrease the gas pressure.

After high manifold pressure has been checked, set heater to operate on low heat.

5. Adjust the low pressure regulator to match the Conversion Documentation Label.
6. Turn the inner adjustment screw for LO pressure clockwise (CW) to increase or counterclockwise (CCW) to decrease the gas pressure. See Fig. 20.

With the heater operating, the pressure gauges must read the pressures specified on the natural gas conversion documentation label.

7. Once pressure has been set close the heater gas supply valve and disconnect from its electrical supply.

FIG. 20

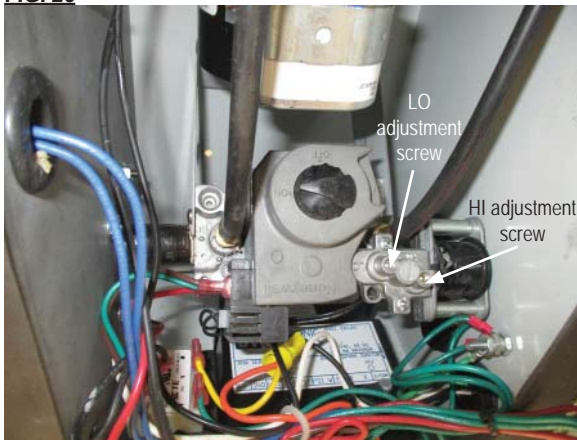

Section F: Completion

For either Single or Two Stage Gas Valve:

1. Remove gauges tubes and pressure barb fittings from inlet and outlet of gas control valve.
2. Install the pressure tap plugs, tightening securely.

Single Stage Gas Valve

- Install the O-ring into the groove on the silver regulator cap screw, as supplied in the Honeywell conversion kit. See Fig.21. Install silver cap screw onto the gas control valve.

FIG. 21



Two Stage Valve

- Install pressure regulator adjustment cap onto the pressure regulator cover. See Fig. 22.

FIG. 22

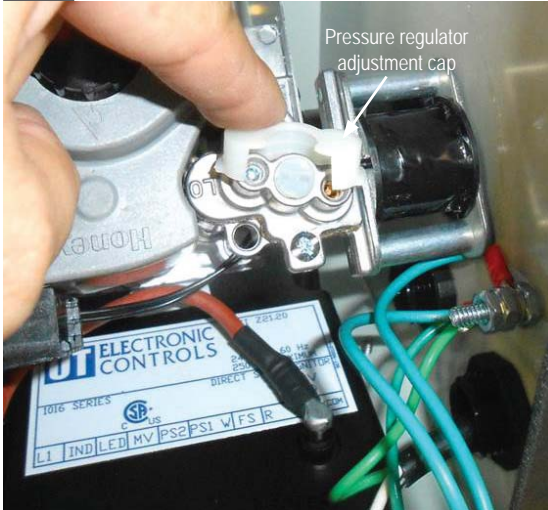

3. Rotate gas control valve back to original position and secure with screws removed earlier.
4. Apply the Yellow ATTENTION label, as supplied in Honeywell conversion kit, to gas control valve. See Fig. 23.

FIG. 24

7. Close and latch the burner box panel.
8. Open the heater's main gas supply valve.
9. Attach supply air flex tube onto heater.
10. Start the heater, and check for proper operation.
11. Set thermostat to desired temperature.

Notes

Service

Contact your local L.B. White dealer for replacement parts and service. You may also call the L.B. White Co., Inc. at 1-800-345-7200, for assistance, or email us at customerservice@lbwhite.com.

Be sure that you have your heater model number and configuration number when calling.



**WORLD PROVIDER - INNOVATIVE
HEATING SOLUTIONS**

411 Mason Street, Onalaska, WI 54650

800-345-7200 • 608-783-5691

608-783-6115 (fax)

www.lbwhite.com